

COLOR AND FINISH CODES

**GRX-4S-DW-\_\_**  
**7-Button ARCHITRAVE™**  
**Door Jamb Wallstation**

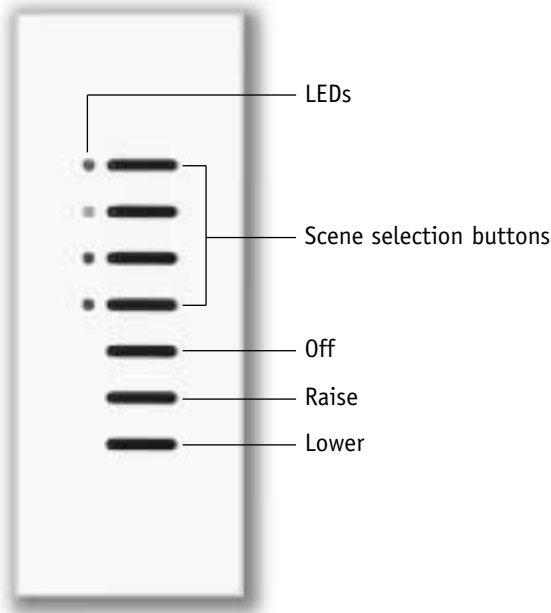

**DESCRIPTION**









Fits into door jamb — occupants can adjust lighting as they enter a room.

- Scene selection buttons activate scenes 1 to 4, 5 to 8, 9 to 12, or 13 to 16 depending on how you set DIP switches 5 and 6.
- Status LEDs show which scene is selected.
- Off button turns all lights off.
- Raise and lower buttons brighten or dim all lighting in the selected scene.

Works with GRX-3000 and GRX-4000 Control Units. Can be set up to select scenes in just one Control Unit or a group of up to eight Control Units.

Mounts in Lutron-supplied wallbox P/N 241-399.

**FUNCTIONS**

DIP SWITCH SETTINGS		Scene selection buttons activate...
5	6	
		Scenes 1 to 4
		Scenes 5 to 8
		Scenes 9 to 12
		Scenes 13 to 16

<b>JOB NAME:</b>	<b>MODEL NUMBERS:</b>
<b>JOB NUMBER:</b>	

**SPECIFICATIONS**

**Power**

Operating voltage: Low-voltage type Class 2(PELV), 12VDC to 24VFW.

**Key Design Features**

- Meets IEC 801-2. Tested to withstand 15kV electrostatic discharge without damage or memory loss.
- Has faceplate that snaps on with no visible means of attachment.

**System Communications and Capacity**

- Low-voltage type Class 2 (PELV) wiring connects Wallstations to Control Units and other components.
- You can link up to 8 Control Units and up to 16 total Wallstations and/or Control Interfaces for a total of 24 control points.

**Terminals**

Capacity: Accept up to two #18 AWG (1.0mm<sup>2</sup>) typical.

**Environment**

32-104°F (0-40°C). Relative humidity less than 90% non-condensing.

**MOUNTING**

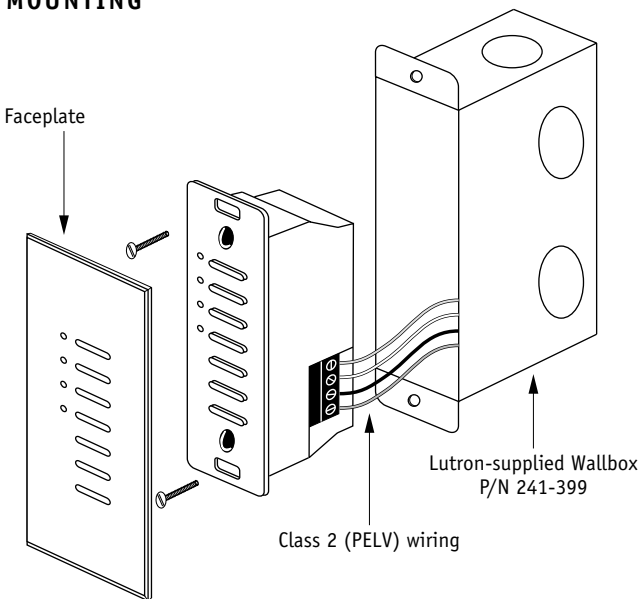

**COLOR AND FINISH CODES**

**Standard**

- Ships in 48 hours
- White **WH**
- Bright Brass **BB**

**Matte Finishes**

- Standard – Ships in 48 hours
- Ivory **IV**
- Beige **BE**
- Gray **GR**
- Brown **BR**
- Black **BL**

**Metal Finishes**

- Ships in 4 to 6 weeks
- Bright Chrome **BC**
- Bright Nickel **BN**
- Satin Brass **SB**
- Satin Chrome **SC**
- Satin Nickel **SN**
- Antique Brass **QB**
- Antique Bronze **QZ**

**Anodized Aluminum**

- Ships in 4 to 6 weeks
- Clear **CLA**
- Black **BLA**
- Brass **BRA**

Custom Controls, color matching, and engraving available – Ships in 4 to 6 weeks. Pricing may vary depending on finish.

**DIMENSIONS**

**Front View**

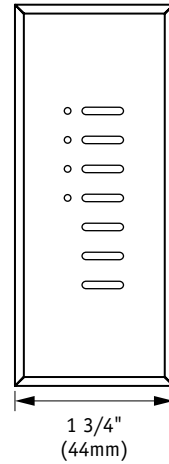

**Side View**

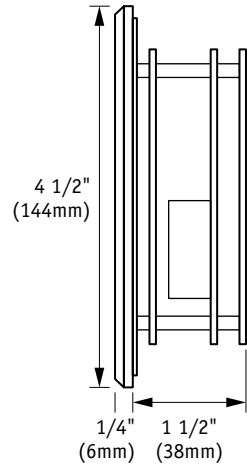

**Back View**

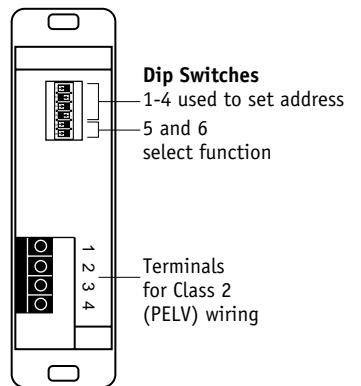

JOB NAME:	MODEL NUMBERS:
JOB NUMBER:	

# Wallstation Installation

## DIP SWITCHES

- Set DIP switches 1-4 to give the Wallstation the unique system address from 1 to 16.
- Set additional DIP switches (if any) to specify function as shown on the first page of the Wallstation's Specification Submittal.

Address	DIP SWITCH SETTINGS			
	1	2	3	4
1				
2				
3				
4				
5				
6				
7				
8				
9				
10				
11				
12				
13				
14				
15				
16				

Reserved for GRX-PRG, if present on link.

## LOW-VOLTAGE CLASS 2 (PELV) WIRING

- Use low-voltage Class 2 (PELV) wiring to daisy-chain Wallstations to Control Units and other components.
- Make connections inside the wallbox. Or in a switchbox or junction box with a maximum wire length of 8 feet (2.5m) from the link to the Wallstation.

Note: EGRX Eurostyle Wallstations have a D terminal for Drain. You can connect the Drain/Shield at this terminal.

### When used with GRX-3000 Control Units

- Two #18 AWG (1.0mm<sup>2</sup>) conductors for common (terminal 1) and 12VDC (terminal 2). Make sure you wire the the terminal 2 connection correctly. Refer to GRX-3000 Specification Submittal.
- One shielded, twisted pair #18 AWG (1.0mm<sup>2</sup>) for data link (terminals 3 and 4).

### When used with GRX-4000 Control Units

- Two #12 AWG (2.5mm<sup>2</sup>) conductors for common (terminal 1) and 24VFW (terminal 2). These won't fit in terminals. Connect as shown.
- One shielded, twisted pair #18 AWG (1.0mm<sup>2</sup>) for data link (terminals 3 and 4).
- Connect Drain/Shield as shown.
  - Do not connect to Ground (Earth) or Wallstation.
  - Connect the bare drain wires and cut off the outside shield.

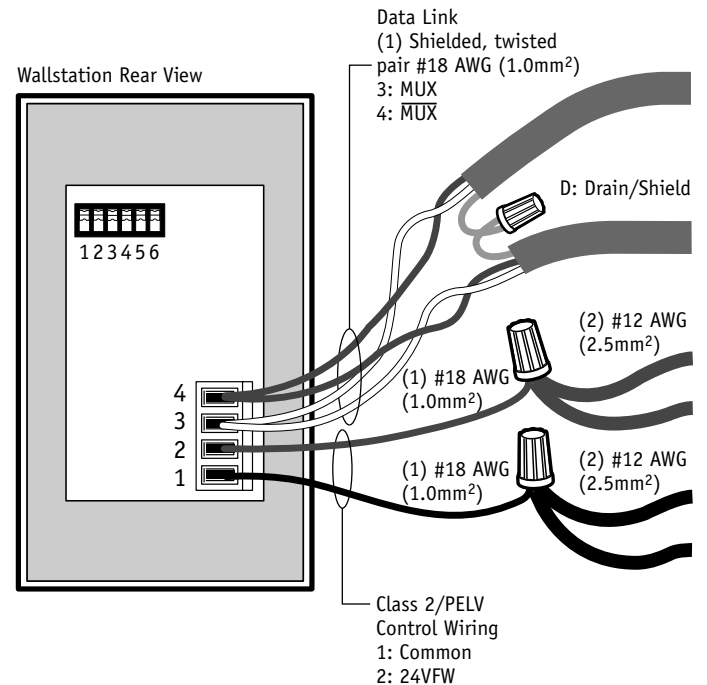

<b>JOB NAME:</b>	<b>MODEL NUMBERS:</b>
<b>JOB NUMBER:</b>	